



Made in Italy

CORMIDI



CMF

ENGINE: 24,8 HP - DIESEL

OPERATIONAL CAPACITY: 1200 KG - 1500 KG - 1600 KG

Through thorough testing and optimization, our machines are being continuously improved to offer you the best solution for your work. Our machines are the most efficient and highest performing on the market.



We put lots of effort into creating an undercarriage track that will never come off, so you can focus on your job.



Cormidi CMF series has become the benchmark for machines in its class. Its ability to meet customer's needs regarding great performance, extreme reliability and reduced fuel consumption is outstanding.

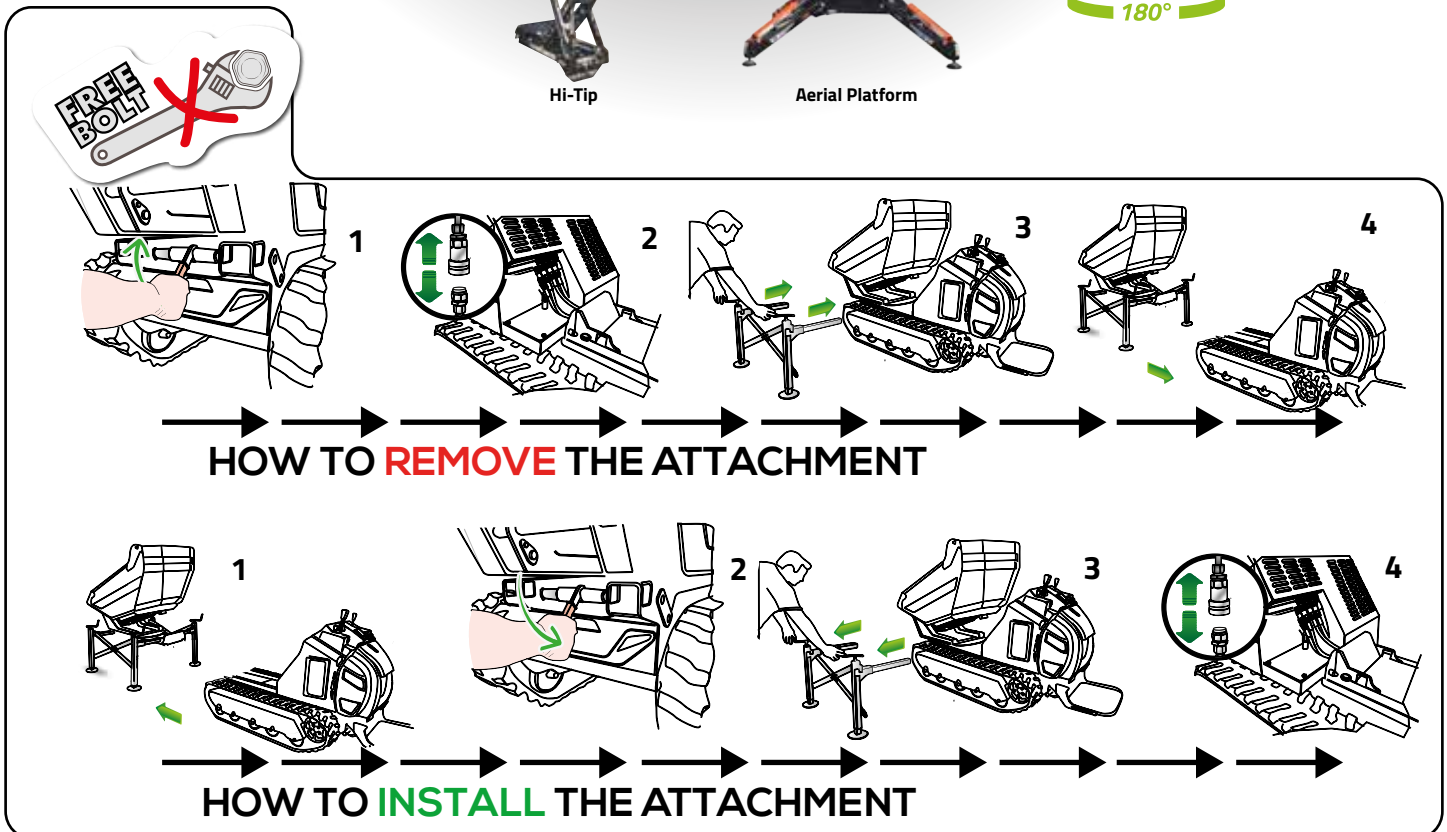

ONE STOP MAINTENANCE

All the daily maintenance checks (such as levels, filters, and fuses) are easily accessible, reducing the time you spend on machine inspection.



FLOAT OPTION ARM

All machines come with an easily-activated float option arm.



HORN

The horn is easily accessible to increase safety of operations.



CHECK OIL

There is a single access point for checking the level, checking the temperature, and filling hydraulic oil.



PARKING BRAKE

The machines have a parking brake to keep the machine safe and to use in emergencies.

QUICK ATTACH

With the Cormidi Quick Attach, you can use a different attachment each time you run the machine (dumper, miniloader, concrete mixer, etc.) Simply attach, check the configuration, and use.

DASHBOARD

The dashboard provides all your information in one place: tachometer, hour meter, fuel gauge, and alarm light.

BUZZER

Every alarm has a loud buzzer that will grab your attention.

SAFETY

Every attachment has safety bars and protections so you can work safely.



ANTI-STALL POWER SYSTEM (ASPS)

The Anti-Stall Power System guarantees excellent performance by allowing you to optimize the power of the machine while running your tools. It allows you to allocate more power to the tools with speed control, ensuring your engine never overloads.



HYD OUTPUT AUX

The machine provides three auxiliary outputs that allow you to use different tools at the same time.



SET HYD LEVERS

This option allows you to change the function of the levers, making the machine more comfortable and customizable to your preferences and needs.



AUTO LEVELLING (ON REQUEST)

Automatic leveling of the forks



UNDERCARRIAGE

The unique design of this undercarriage is advantageous to your work safety and provides a comfortable drive in all conditions. The rubber track is long-lasting and never comes off.rocking rollers system ensures you'll have amazing traction over a wide variety of terrains.

LIFTING HOOK

The machine is easy to transport anywhere you need it.

HI-FLOW

The CMF machine has a unique Hi-Flow system with two variable piston pumps with automatic constant power. This allows the machine to use the most power available and prevents the engine from stalling.

UNIVERSAL FRONT PLATE



The front plate allows you to use any mini-load-er attachment on the market.

FOLD-UP PLATFORM PLATE

When you need more space, simply fold up the platform plate for sixteen fewer inches.



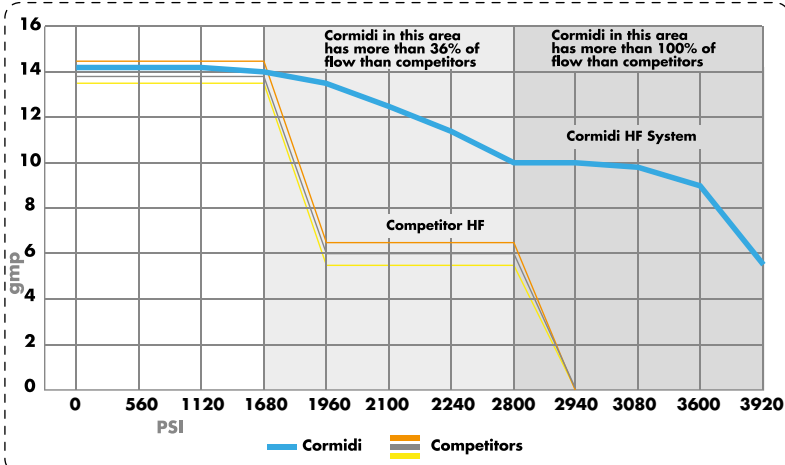

HI-FLOW

Cormidi machines have the most efficient Hi-Flow system available on the market. Two variable piston pumps with automatic constant power means the machine can use the maximum power available without the engine stalling.

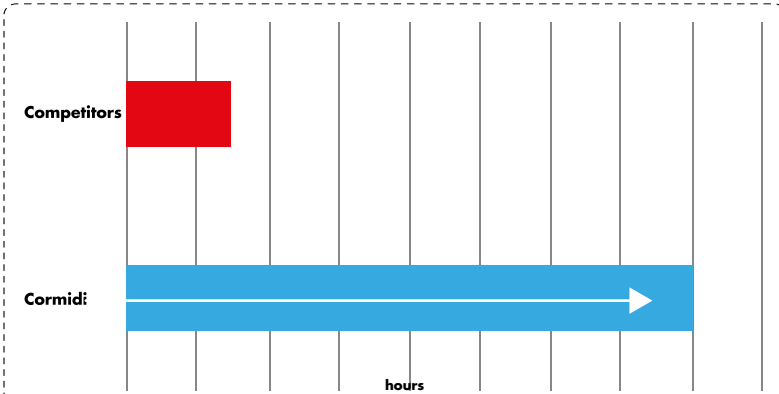

RUBBER TRACK LIFE

Cormidi's undercarriage is the best and longest-lasting heavy-duty undercarriage in its class.

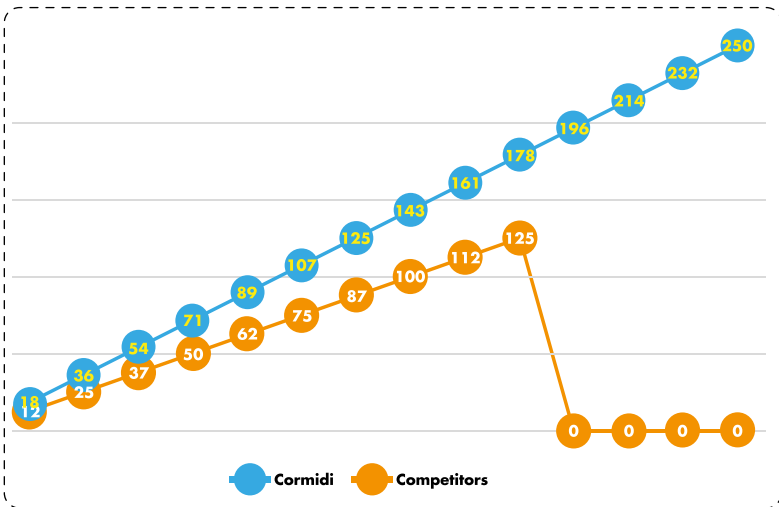

TORQUE TRANSMISSION

Cormidi uses the most advanced technology on the market for its transmission to reduce fuel consumption while increasing performance.

SPECS DIFFERENCES



SPEC 1

This configuration provides a hydraulic circuit with two distributor elements that allow the machine to perform two actions at the same time through movement of the lever.



SPEC 2

This configuration adds a second distributor to the Spec 1 configuration, allowing three additional actions for a total of five actions.

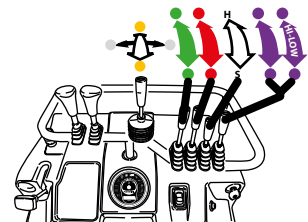

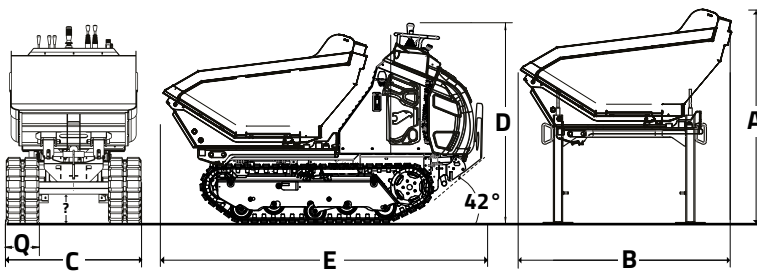

SPEC 3

This configuration is identical to Spec 2, with the addition of another hydraulic pump to create a Hi-Flow circuit. This allows the use of equipment that require more GPM, such as the Snow Turbine, Weed Wacker, Harley Rack, etc.



	C1200		C1500		C1600	
	mm	in	mm	in	mm	in
A	1224	48.2	1224	48.2	1224	48.2
B	1488	58.6	1593	62.7	1593	62.7
C	865	34.1	895	35.2	945	37.2
D	1350	53.2	1350	53.2	1350	53.2
Q	200	7.9	230	9.1	230	9.1
E	2333	91.7	2430	95.7	2430	95.7



	C1200	C1500	C1600
OPERATIVE CAPACITY	1200 kg 2646 Lb	1500 kg 3307 Lb	1600 kg 3527 Lb
ATTACHMENT WEIGHT 	210 kg 485 Lb	220 kg 485 Lb	220 kg 485 Lb
MACHINE WEIGHT 	795 kg 1753 Lb	910 kg 2006 Lb	919 kg 2027 Lb
TOTAL WEIGHT 	1051 kg 2317 Lb	1130 kg 2491 Lb	1139 kg 2511 Lb
STRUCK	0,36 m³ 0.47 yd³	0,42 m³ 0.55 yd³	0,45 m³ 0.59 yd³
HEAPED SAE	0,50 m³ 0.65 yd³	0,60 m³ 0.79 yd³	0,63 m³ 0.82 yd³

1

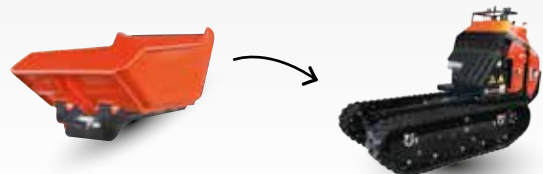

Dumper skip

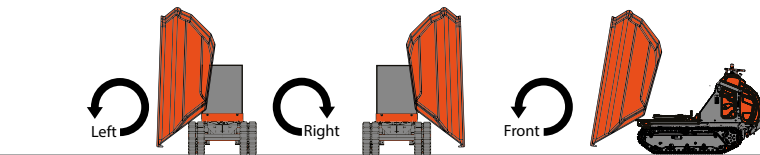
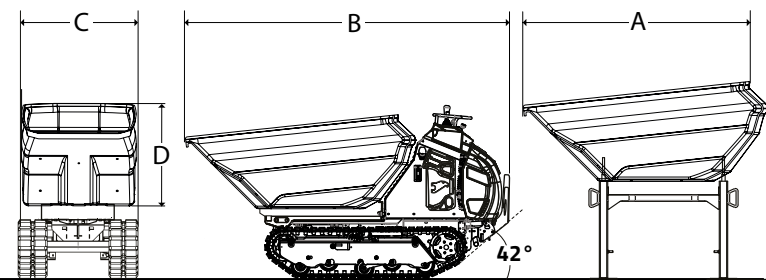



	C1500		C1600	
	mm	in	mm	in
A	1810	71.3	1810	71.3
B	2845	112	2845	112
C	892	35	892	35
D	799	31.5	799	31.5



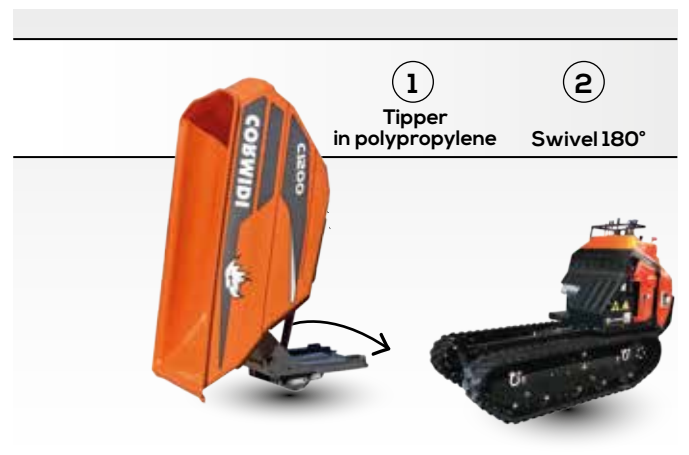

	C1500	C1600
OPERATIVE CAPACITY	1500 kg 3307 Lb	1600 kg 3527 Lb
ATTACHMENT WEIGHT 	290 kg 639 Lb	290 kg 639 Lb
MACHINE WEIGHT 	910 kg 2006 Lb	919 kg 2027 Lb
TOTAL WEIGHT 	1200 kg 2646 Lb	1209 kg 2665 Lb
STRUCK	0,82 m ³ 1,07 yd ³	0,82 m ³ 1,07 yd ³
HEAPED SAE	1,09 m ³ 1,43 yd ³	1,09 m ³ 1,43 yd ³

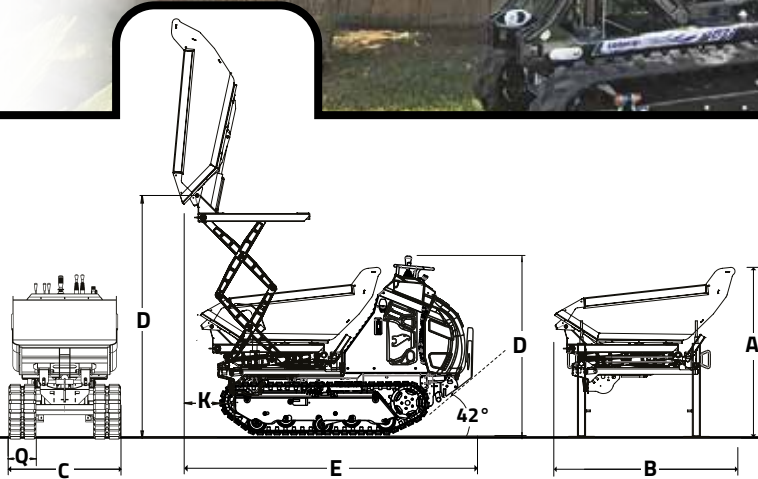
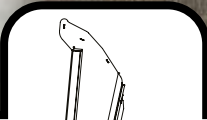



	C1200		C1500		C1600	
	mm	in	mm	in	mm	in
A	1410	55.5	1410	55.5	1410	55.5
B	1493	58.8	1593	62.7	1593	62.7
C	865	34.1	895	35.2	945	37.2
D	1990	78.4	2060	53.2	2060	53.2
Q	200	7.9	230	9.1	230	9.1
E	2263	89.1	2395	94.3	2395	94.3
K	310	12.2	310	12.2	310	12.2



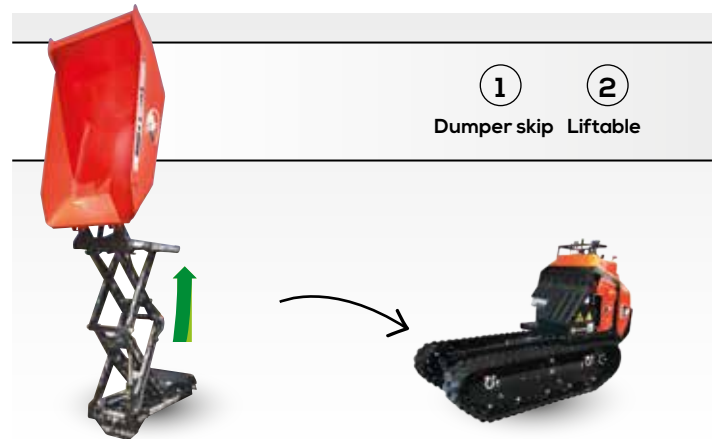

	C1200	C1500	C1600
OPERATIVE CAPACITY	1200 kg 2646 Lb	1500 kg 3307 Lb	1600 kg 3527 Lb
ATTACHMENT WEIGHT 	343 kg 756.2 Lb	363 kg 800.3 Lb	363 kg 800.3 Lb
MACHINE WEIGHT 	795 kg 1753 Lb	910 kg 2006 Lb	919 kg 2027 Lb
TOTAL WEIGHT 	1138 kg 2508.9 Lb	1273 kg 2806.5 Lb	1282 kg 2826.3 Lb
STRUCK	0,36 m³ 0.47 yd³	0,42 m³ 0.55 yd³	0,45 m³ 0.59 yd³
HEAPED SAE	0,50 m³ 0.65 yd³	0,60 m³ 0.79 yd³	0,63 m³ 0.82 yd³

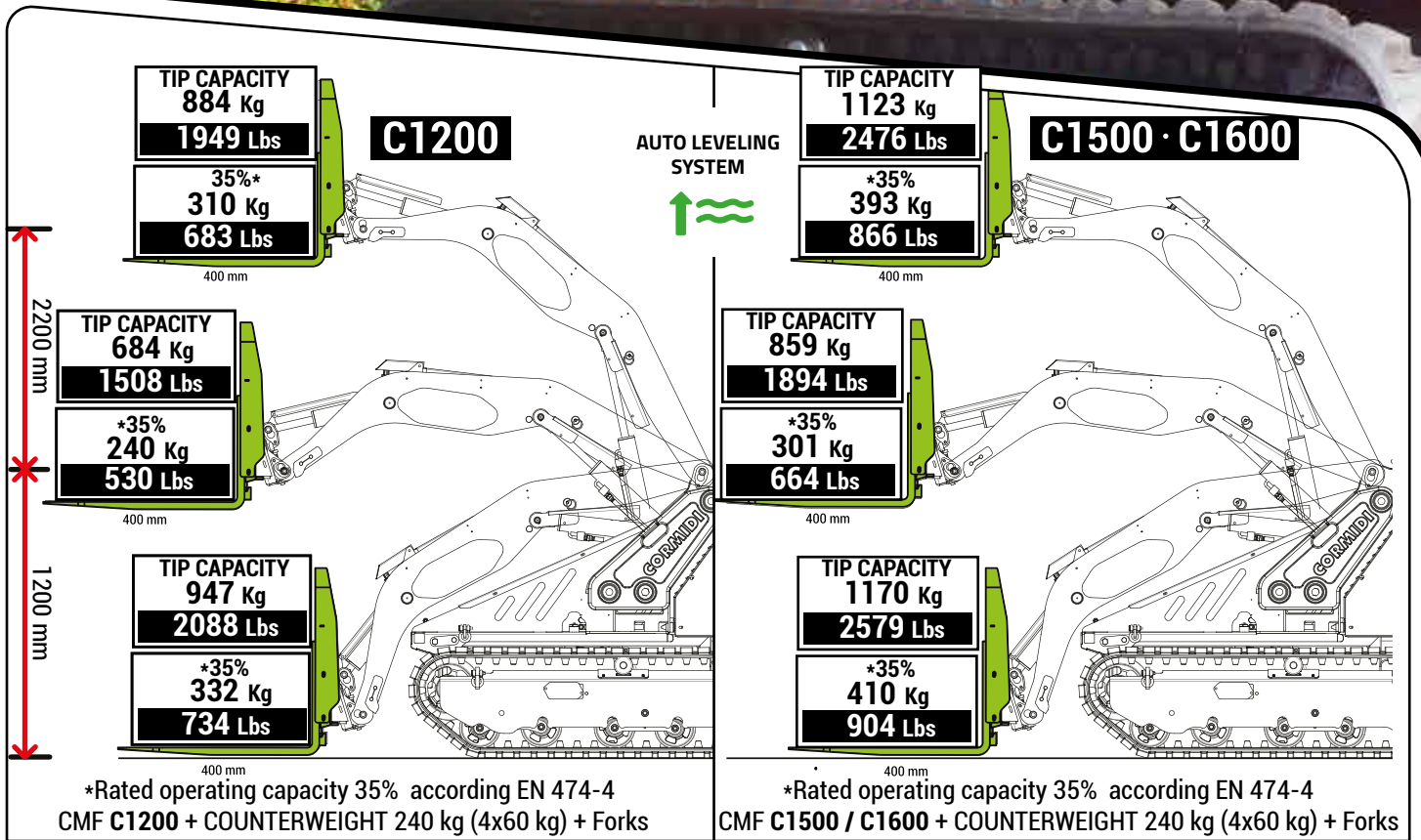



	C1200		C1500		C1600	
	mm	in	mm	in	mm	in
A	2700	106.3	3000	118.1	3000	118.1
B	1370	53.9	1370	53.9	1370	53.9
C	2090	82.3	2200	86.6	2200	86.6
D	1045	41.1	1045	41.1	1045	41.1
E	865	34.1	895	35.2	945	37.2
F	250	9.8	250	9.8	250	9.8

	C1200	C1500	C1600
OPERATIVE CAPACITY	1200 kg 2646 Lb	1500 kg 3307 Lb	1600 kg 3527 Lb
ATTACHMENT WEIGHT 	425 kg 937 Lb	474 kg 1045 Lb	474 kg 1045 Lb
MACHINE WEIGHT 	795 kg 1753 Lb	910 kg 2006 Lb	919 kg 2027 Lb
TOTAL WEIGHT 	1220 kg 2690 Lb	1384 kg 3051 Lb	1393 kg 3072 Lb

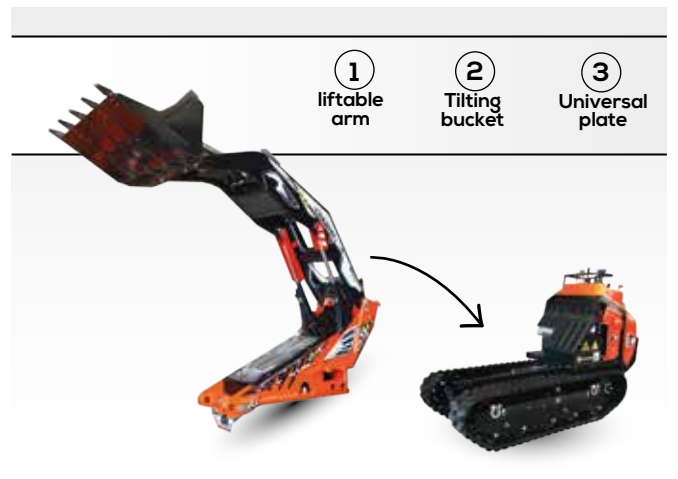



Automatic system: **AUCO System**

How to **insert** the attachment

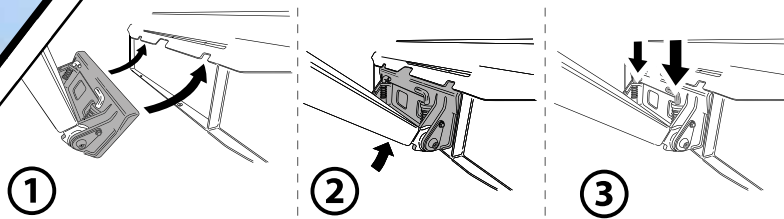

How to **disconnect** the attachment

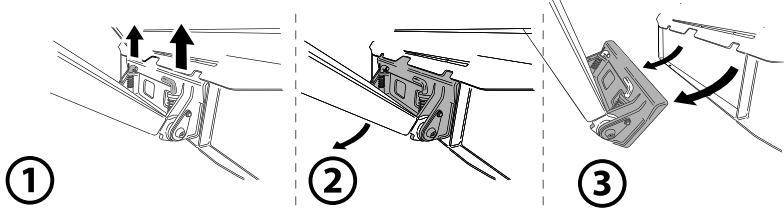

UNIVERSAL PLATE



it also accepts non-Cormidi brand accessories which mount on Bobcat, Vermeer, Toro, others.

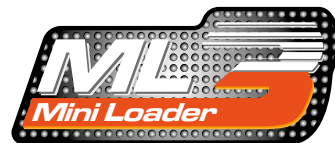



Original accessories available for CMF + ML:

Cormidi

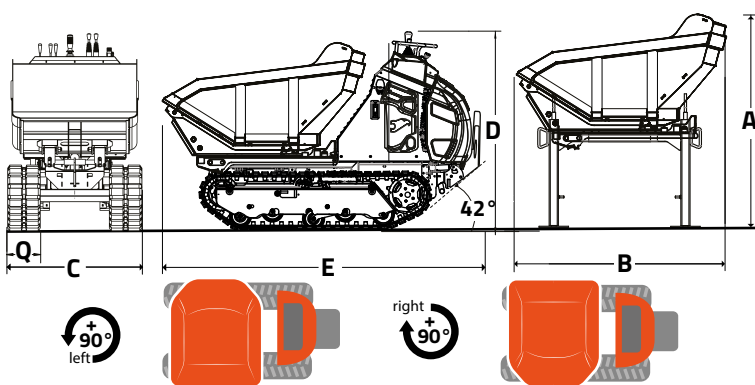
-  Bucket teeth
-  Light Material Bucket
-  4-in-1 bucket
-  Manure Fork Grapple
-  Manure fork
-  Leveller
-  Ripper
-  Grilled bucket with split grapple
-  Bucket with grapple
-  Towing plate
-  Universal plate
-  Forks
-  Grapple rake
-  Grabs
-  Sweeper bucket
-  Front screening bucket
-  Mixing bucket safe discharge
-  Auger
-  Mulcher
-  Stone burier
-  Tiller
-  Snow Blade
-  Dozer
-  Snow turbine
-  Stump grinder
-  Trencher
-  Hedge bush cutters



	C1200		C1500		C1600	
	mm	in	mm	in	mm	in
A	1224	48.2	1224	48.2	1224	48.2
B	1488	58.6	1593	62.7	1593	62.7
C	865	34.1	895	35.2	945	37.2
D	1350	53.2	1350	53.2	1350	53.2
Q	200	7.9	230	9.1	230	9.1
E	2333	91.7	2430	95.7	2430	95.7



	C1200	C1500	C1600
OPERATIVE CAPACITY	1200 kg 2646 Lb	1500 kg 3307 Lb	1600 kg 3527 Lb
ATTACHMENT WEIGHT 	210 kg 485 Lb	220 kg 485 Lb	220 kg 485 Lb
MACHINE WEIGHT 	795 kg 1753 Lb	910 kg 2006 Lb	919 kg 2027 Lb
TOTAL WEIGHT 	1051 kg 2317 Lb	1130 kg 2491 Lb	1139 kg 2511 Lb
STRUCK	0,36 m³ 0.47 yd³	0,42 m³ 0.55 yd³	0,45 m³ 0.59 yd³
HEAPED SAE	0,50 m³ 0.65 yd³	0,60 m³ 0.79 yd³	0,63 m³ 0.82 yd³

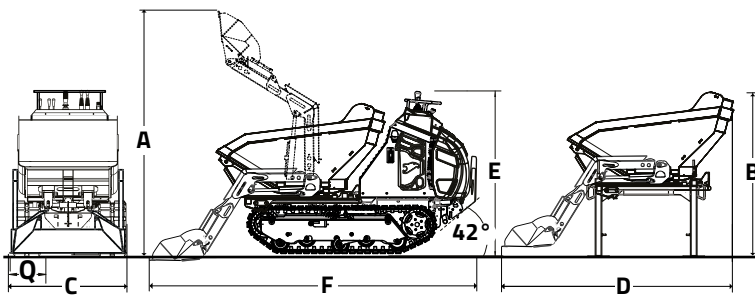



	C1200		C1500		C1600	
	mm	in	mm	in	mm	in
A	2127	83.7	2127	83.7	2127	83.7
B	1230	48.4	1230	48.4	1230	48.4
C	865	34.1	895	35.2	945	37.2
D	2072	81.6	2177	85.7	2177	85.7
E	1350	53.2	1350	53.2	1350	53.2
F	2890	113.8	2940	115.8	2940	115.8
Q	200	7.9	230	9.1	230	9.1



	C1200	C1500	C1600
OPERATIVE CAPACITY	1200 kg 2646 Lb	1500 kg 3307 Lb	1600 kg 3527 Lb
ATTACHMENT WEIGHT 	315 kg 695 Lb	320 kg 706 Lb	320 kg 706 Lb
MACHINE WEIGHT 	795 kg 1753 Lb	910 kg 2006 Lb	919 kg 2027 Lb
TOTAL WEIGHT 	1110 kg 2447 Lb	1230 kg 2712 Lb	1239 kg 2732 Lb
STRUCK	0,29 m³ 0.38 yd³	0,35 m³ 0.46 yd³	0,37 m³ 0.48 yd³
HEAPED SAE	0,39 m³ 0.51 yd³	0,47 m³ 0.62 yd³	0,50 m³ 0.65 yd³



- ①
- ②
- ③

Dumper skip Self loading Tilting bucket

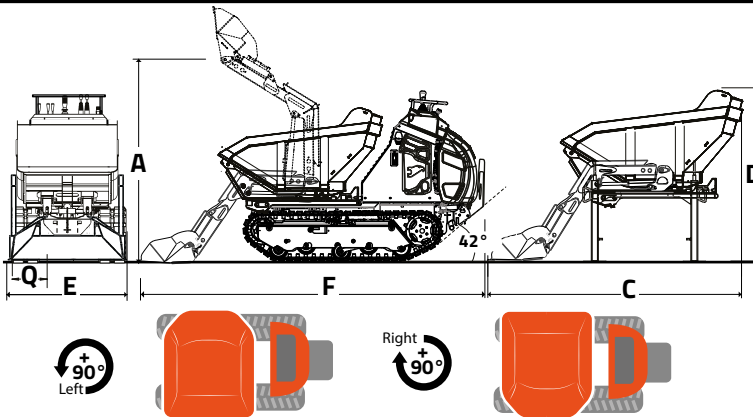



	C1200		C1500		C1600	
	mm	in	mm	in	mm	in
A	1824	71.8	1870	73.6	1870	73.6
C	1980	78.0	2160	85.0	2160	85.0
D	1310	51.6	1310	51.6	1310	51.6
E	910	35.8	910	35.8	910	35.8
F	2870	113	2990	117.7	2990	117.7
Q	200	7.9	230	9.1	230	9.1



	C1200	C1500	C1600
OPERATIVE CAPACITY	1200 kg 2646 Lb	1500 kg 3307 Lb	1600 kg 3527 Lb
ATTACHMENT WEIGHT 	370 kg 816 Lb	380 kg 838 Lb	380 kg 838 Lb
MACHINE WEIGHT 	795 kg 1753 Lb	910 kg 2006 Lb	919 kg 2027 Lb
TOTAL WEIGHT 	1165 kg 2568 Lb	1290 kg 2844 Lb	1299 kg 2864 Lb
STRUCK	0,33 m³ 0.43 yd³	0,39 m³ 0.51 yd³	0,39 m³ 0.51 yd³
HEAPED SAE	0,44 m³ 0.57 yd³	0,51 m³ 0.67 yd³	0,51 m³ 0.67 yd³

- ①
Self loading
- ②
Tilting bucket
- ③
Swivel 180°
- ④
Dumper skip

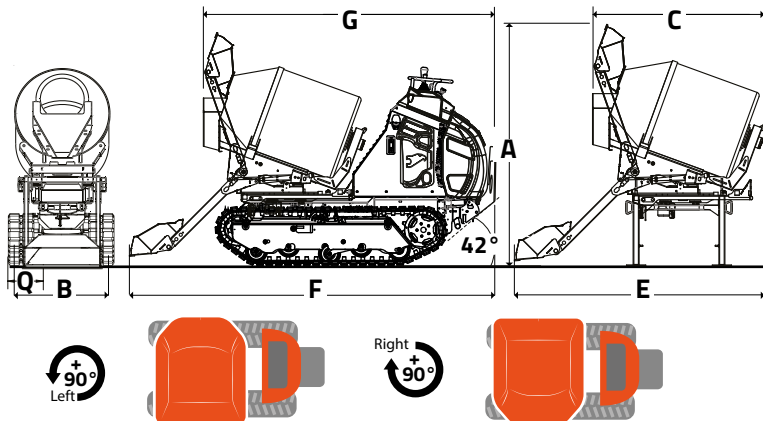



	C1200		C1500		C1600	
	mm	in	mm	in	mm	in
A	1880	74.0	1880	74.0	1880	74.0
B	728	28.7	728	28.7	728	28.7
C	1880	74.0	2060	81.1	2060	81.1
E	2570	101.2	2750	108.3	2750	108.3
F	3200	126.0	3400	133.9	3400	133.9
Q	200	7.9	230	9.1	230	9.1
G	2400	94.5	2600	102.3	2600	102.3

	C1200	C1500	C1600
OPERATIVE CAPACITY	1200 kg 2646 Lb	1500 kg 3307 Lb	1600 kg 3527 Lb
ATTACHMENT WEIGHT 	RI: 325 kg AC: 430 kg 717Lb 948Lb	RI: 345 kg AC: 450 kg 761Lb 992Lb	RI: 345 kg AC: 450 kg 761Lb 992Lb
MACHINE WEIGHT 	795 kg 1753 Lb	910 kg 2006 Lb	919 kg 2027 Lb
TOTAL WEIGHT 	RI: 1120 kg AC: 1225 kg 2469Lb 2701Lb	RI: 1255 kg AC: 1360 kg 2767Lb 2998Lb	RI: 1264 kg AC: 1369 kg 2787Lb 3018Lb
GROSS CAPACITY	450 L 118.9 gal	600 L 158.5 gal	600 L 158.5 gal
NET CAPACITY	265 L 70 gal	350 L 92.5 gal	350 L 92.5 gal





CORMIDI

version: **RIX**

Concrete mix - Swivel 180°

version: **ACX**

Concrete mix - Self loading - Swivel 180°



RIX



ACX

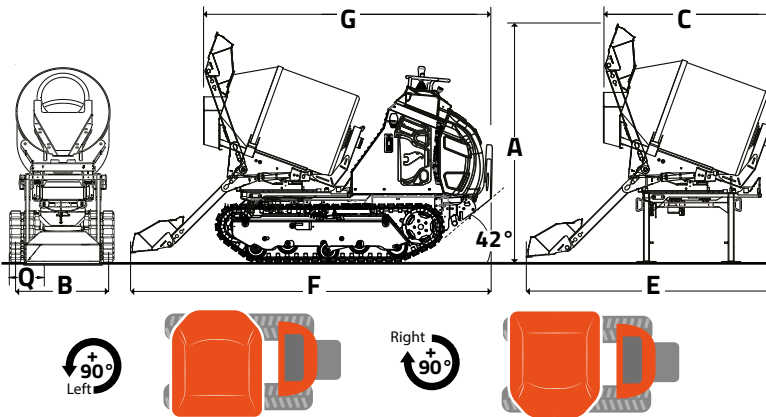



	C1200		C1500		C1600	
	mm	in	mm	in	mm	in
A	1880	74.0	1880	74.0	1880	74.0
B	728	28.7	728	28.7	728	28.7
C	1880	74.0	2060	81.1	2060	81.1
E	2570	101.2	2750	108.3	2750	108.3
F	3200	126.0	3400	133.9	3400	133.9
Q	200	7.9	230	9.1	230	9.1
G	2400	94.5	2600	102.3	2600	102.3

	C1200	C1500	C1600
OPERATIVE CAPACITY	1200 kg 2646 Lb	1500 kg 3307 Lb	1600 kg 3527 Lb
ATTACHMENT WEIGHT	RIX: 405 kg ACX: 500 kg 893 Lb 1102 Lb	RIX: 435 kg ACX: 530 kg 959 Lb 1169 Lb	RIX: 435 kg ACX: 530 kg 959 Lb 1169 Lb
MACHINE WEIGHT	795 kg 1753 Lb	910 kg 2006 Lb	919 kg 2027 Lb
TOTAL WEIGHT	RIX: 1200 kg ACX: 1295 kg 2646Lb 2855Lb	RIX: 1345 kg ACX: 1440 kg 2965Lb 3175Lb	RIX: 1354 kg ACX: 1449 kg 2985Lb 3195Lb
GROSS CAPACITY	450 L 118.9 gal	600 L 158.5 gal	600 L 158.5 gal
NET CAPACITY	265 L 70 gal	350 L 92.5 gal	350 L 92.5 gal

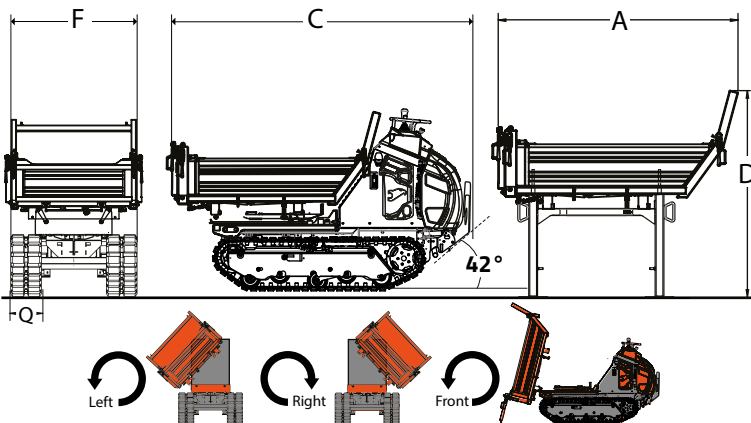



	C1200		C1500		C1600	
	mm	in	mm	in	mm	in
A	1550	61.0	1630	64.2	1630	64.2
C	2330	91.7	2510	98.8	2510	98.8
D	1247	49.1	1247	49.1	1247	49.1
F	1010	39.8	1010	39.8	1010	39.8
Q	200	7.9	230	9.1	230	9.1

	C1200	C1500	C1600
OPERATIVE CAPACITY	1200 kg 2646 Lb	1500 kg 3307 Lb	1600 kg 3527 Lb
ATTACHMENT WEIGHT 	300 kg 661 Lb	320 kg 706 Lb	320 kg 706 Lb
MACHINE WEIGHT 	795 kg 1753 Lb	910 kg 2006 Lb	919 kg 2027 Lb
TOTAL WEIGHT 	1100 kg 2372 Lb	1230 kg 2293 Lb	1049 kg 2313 Lb
STRUCK	0,36 m³ 0.47 yd³	0,39 m³ 0.51 yd³	0,39 m³ 0.51 yd³
HEAPED SAE	0,61 m³ 0.80 yd³	0,67 m³ 0.88 yd³	0,67 m³ 0.88 yd³



1
Tipper

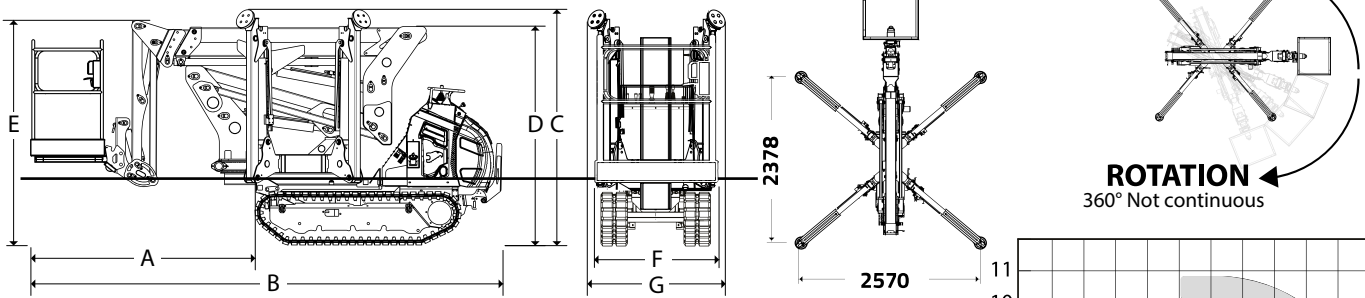



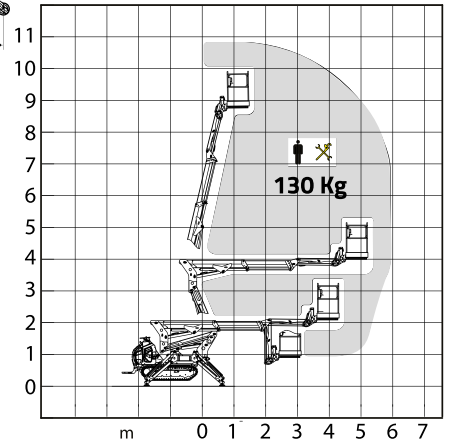

	C1500		C1600	
	mm	in	mm	in
A	1960	77.2	1960	77.2
B	4120	162.2	4120	162.2
C	2030	80.0	2030	80.0
D	1930	76.0	1930	76.0
E	1980	78.0	1980	78.0
F	1060	41.7	1060	41.7
G	1140	44.9	1140	44.9

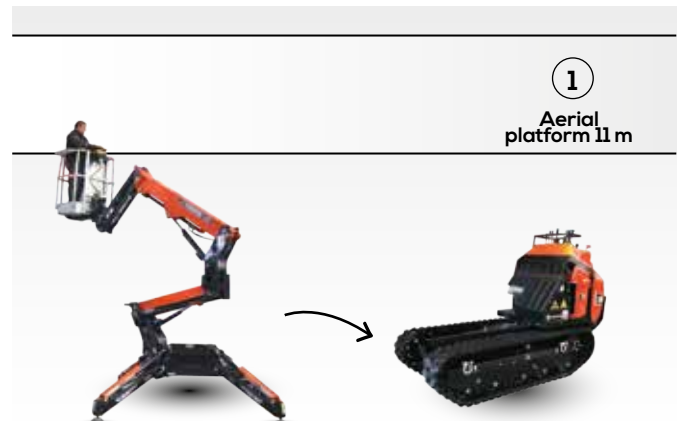

		C1500	C1600
OPERATIVE CAPACITY		1500 kg 3307 Lb	1600 kg 3527 Lb
ATTACHMENT WEIGHT		1100 kg 2425.1 Lb	1100 kg 2425.1 Lb
MACHINE WEIGHT		910 kg 2006 Lb	919 kg 2027 Lb
TOTAL WEIGHT		2010 kg 4431.1 Lb	2019 kg 4452.1 Lb
HEIGHT		11 m 36.1 FT	11 m 36.1 FT
MAX CAPACITY	(f+e)	130 kg 286.6 lb	130 kg 286.6 lb



		1200 kg 2646 lb	1500 kg 3307 lb	1600 kg 3527 lb
ENGINE				
Diesel	Kubota D1105 24,8 hp STAGE V - TIER 4 Kubota D1305 24,8 hp STAGE V - TIER 4	•	•	•
TRANSMISSION				
Type	Hydrostatic	•	•	•
Hydraulic pump	2 variable piston pumps 83.2 lt/min 365bar (21.9 gpm 5230 psi) 2 variable piston pumps 93 lt/min 365bar (24.6 gpm 5234 psi)	•	•	•
TRACKS				
Crawler width	200 mm (7.9 in) 230 mm (9.1 in)	•	•	•
Track roller with grease	n°5	•	•	•
HYDRAULIC SYSTEM SPEC 1 - 2				
Hydraulic pump	Gear pump	•	•	•
Flow std	1x26/min 200 bar (1x 6.86 gpm 2901 psi) 1x27 l/min 200 bar (1x7.1 gpm 2901 psi)	•	•	•
HYDRAULIC SYSTEM WITH HI FLOW SPEC 3				
Hydraulic pump	variable pistons pumps	•	•	•
Hi-Flow	2x27=54 l/min 280 bar / (2x 7.1= 14.2 gpm 4061 psi) 2x29=58 l/min 280 bar / (1x 7.7= 15.4 gpm 4061 psi)	•	•	•
HYDRAULIC SYSTEM SPEC 2 (Only U.S.A.)				
Flow std	 1x36,3 lt/min 180 bar (1x9.6 gpm 2611 psi) 1x39,7 lt/min 180 bar (1x10.5 gpm 2611 psi)	•	•	•
HYDRAULIC SYSTEM WITH HI FLOW SPEC 3 (Only U.S.A.)				
Hi-Flow	 2x27=54 lt/min 280 bar 1x/ (2x 7= 14 gpm 4061 psi) 2x29=58 l/min 280 bar / (1x 7.67= 15.34 gpm 4061 psi)	•	•	•
ADDITIONAL HYD OUTPUT				
Spec-1	n° 2	•	•	•
Spec-2	n° 5	•	•	•
Spec-3	n° 5	•	•	•
PERFORMANCE AND DIMENSIONS				
Max. Travel Speed	6,9 Km/h (4.3 mph)	•	•	•
Max. Travel Speed	7,6 Km/h (4.7 mph)	•	•	•
Dry Weight	795 Kg (1753 lb) 910 Kg (2006 lb) 919 kg (2027 lb)	•	•	•
Parking brake	Yes	•	•	•
Cruise control	Yes	•	•	•

	mm	mm	mm	mm	mm	mm	mm
	(A)	(C)	(L)	(M)	(N)	(O)	(Z)
1200	2060	1660	865	1370	250	200	42°
1500	2160	1770	895	1370	250	230	42°
1600	2160	1770	945	1370	250	230	42°

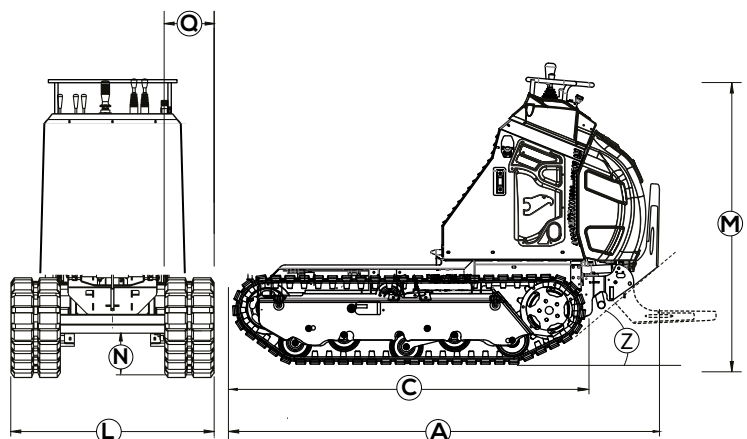

EN

Radio control Available on request on the CMF range



Please note: The machines and accessories depicted in brochures and catalogues can vary from version to version, therefore please consult your distributor for a description of standard accessories and options available for each model. Cormidi reserves the right to change or to modify the specification of the machines without warning. The photos in catalogues and brochures represent the Cormidi machines in production at time of printing. However, newer and upgraded models may look different to the photos shown in this catalogue or brochure.



CORMIDI



Via Fonte, 342 Roccadaspide
(SA) Italy
ph. +39 0828 943688
fax +39 0828 943963

info@cormidi.com - www.cormidi.com

292 Roosevelt Dr, Seymour
CT 06483, Stati Uniti
ph.+1 203-846-6120
art@cormidiusa.com

