



TECHNICAL DATA

MASSES

Mass (incl. standard screed)	8.8 t
Mass (tractor)	6.8 t

DIMENSIONS

Front ramp angle	11°
Standard Paving Width	2.4-4.7 m
Transport width	2.60 m
Working width, hydraulic extendable	4.70 m
Working width, max.	5.50 m
Working width, minimum (with reducing shoe)	0.30 m

CAPACITY

Paving thickness (max/min)	150 mm / 0 mm
Theoretical placement capacity	550 t/h

MATERIAL HOPPER

Capacity	7.3 t
Dumping height, center	406 mm
Hopper width, internal	3125 mm

TRACTION

Paving speed	0-43 mpm
Transport speed	5.0 km/h

ENGINE

Electrical system	12V
Emissions according to	EPA T4f/EU4
Engine alternator capacity	140 Amps
Fuel tank capacity	83 l
Heating generator capacity	16 kW, 240 V 1 phase
Manufacturer/Model	Cummins QSF 3.8
Rated power, SAE J1995	120 hp @ 2200 rpm

UNDERCARRIAGE

Crawler length	1830 mm
Crawler width	355 mm
Final drive	Hydrostatic with gear reducer
Type	Steel track with poly pad

CONVEYOR

Conveyor control	Automatic with Auger control
Conveyor type	Dual slat conveyor
Conveyor width	560 mm

AUGER

Auger control	Automatically with ultrasonic sensor
Auger diameter	304.80 mm
Extension auger	230 mm (9 in) mounted on screed extensions

Find us locally at www.dynapac.com

We reserve the right to change specifications without notice. Photos and illustrations do not always show standard versions of machines. The above information is a general description only, all informations are supplied without liability.



DIMENSIONS

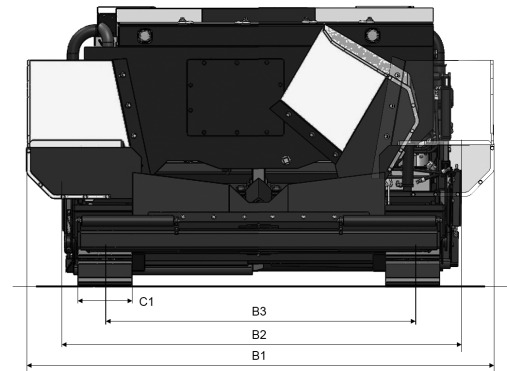
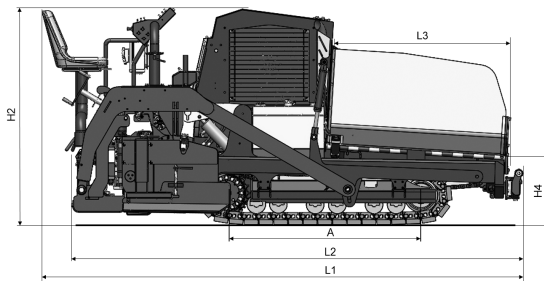

DIMENSIONS

A. Axle track	1830 mm
B1. Width, max.	3175 mm
B2. Width, standard	2590 mm
B3. Width, center of tracks	1930 mm
C1. Track width	355 mm
H2. Height, transport	1800 mm
H4. Dumping height	406 mm
L1. Length, total	4190 mm
L3. Length, hopper	1650 mm

STANDARD EQUIPMENT

- LED Work Lights
- Backup Alarm & Rotating Beacon
- Reversible auger and conveyor
- Rebuildable wear resistance conveyor floor plates
- Segmented High Wear Augers
- Hydraulic Tow Point
- Screed Power Crown
- Screed Power Match height
- Dyn@link Telematics
- Ultrasonic sensors auger
- Wash down spray system
- Dual operator console with conventional electrics
- Screed ext. power slope control
- Heated end gate

OPTIONAL EQUIPMENT

- Road Crew Kit
- 3 Man operation
- Levelling System
- Averaging Ski beam
- CutOff plates
- Screed Extension
- Truck Hitch
- Umbrella

Find us locally at www.dynapac.com



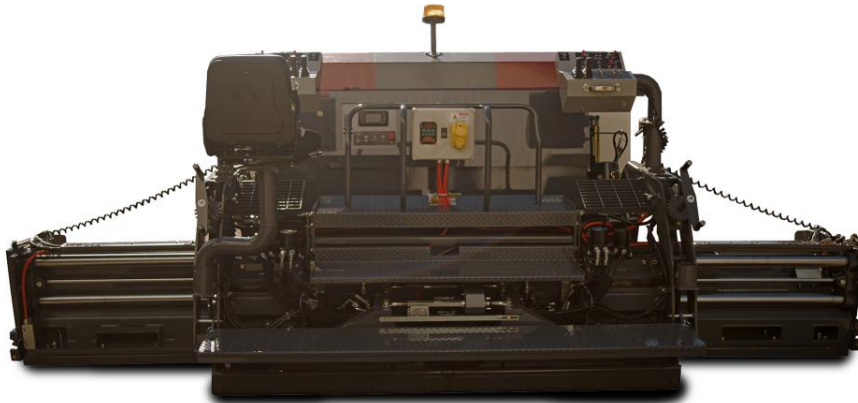





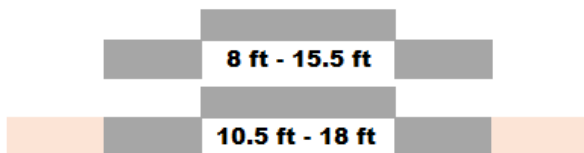

We reserve the right to change specifications without notice. Photos and illustrations do not always show standard versions of machines. The above information is a general description only, all informations are supplied without liability.



COMPATIBLE SCREEDS

VF0816C



- | | | | |
|--|--|---|-----------------------|
|  | 750 mm extension box |  | 1275 mm V5100 section |
|  | 350 mm extension box |  | 1500 mm V6000 section |
|  | Not available for TH E screeds | | |
|  | 3000 mm R300 basic screed | | |
|  | 1375 mm – 2375 mm Hydraulic Extendable Extension box | | |
|  | 1000 mm extension box |  | 500 mm extension box |
|  | 750 mm extension box |  | 250 mm extension box |

Find us locally at www.dynapac.com

We reserve the right to change specifications without notice. Photos and illustrations do not always show standard versions of machines. The above information is a general description only, all informations are supplied without liability.