

# Dynapac FC1300C II

## Commercial pavers



### Technical data

 <b>Masses</b>	
Mass (tractor)	3.6 t
Mass (incl. standard screed)	4.5 t

  

 <b>Dimensions</b>	
Working width, max.	4.0 m
Working width, hydraulic extendable	4.0 m
Working width, minimum (with reducing shoe)	0.3 m
Front ramp angle	11°
Transport width	2.60 m

  

 <b>Capacity</b>	
Theoretical placement capacity	180 t/h
Paving thickness (max/min)	150 mm / 0 mm

  

 <b>Undercarriage</b>	
Type	Steel Track with Poly Pads
Crawler length	1015 mm
Crawler width	305 mm
Final drive	Hydrostatic w/Gear Reducer

  

 <b>Traction</b>	
Paving speed	0-30 mpm
Transport speed	5.0 km/h

 <b>Engine</b>	
Manufacturer/Model	Kubota D1505
Emissions according to	EPA T4f/EU4
Rated power, SAE J1995	24 hp @ 2300 rpm
Electrical system	12 V
Fuel tank capacity	76 l
Engine alternator capacity	60 Amps

 <b>Engine</b>	
Manufacturer/Model	Kubota D1505, EPA T3
Rated power	38 hp @ 2300 rpm
Rated power [engine 2, kW]	28 kW
Rated power [engine 2, rpm]	2200 rpm

 <b>Material hopper</b>	
Capacity	5.5 t
Dumping height, center	585 mm
Hopper width, internal	2921 mm

 <b>Auger</b>	
Auger diameter	230 mm
Auger control	Automatic with wisker switch
Extension auger	230mm, Mounted on Screed Ext

Find us locally at [www.dynapac.com](http://www.dynapac.com)

We reserve the right to change specifications without notice. Photos and illustrations do not always show standard versions of machines. The above information is a general description only, all informations are supplied without liability.

# Dynapac FC1300C II

## Commercial pavers



### Technical data

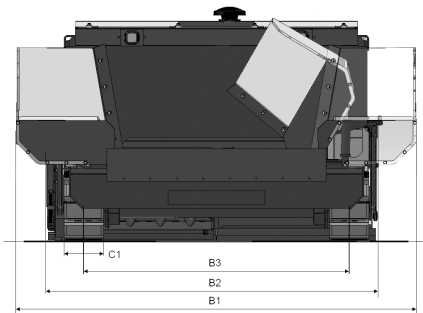
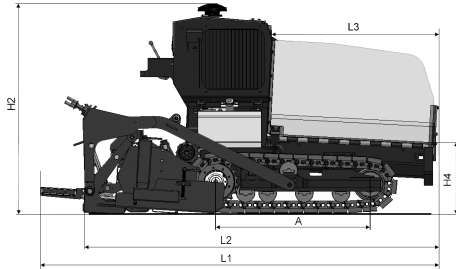

Dimensions	
A. Axle track	1016 mm
B1. Width, max.	2921 mm
B2. Width, standard	2590 mm
B3. Width, center of tracks	2032 mm
C1. Track width	305 mm
H2. Height, transport	1727 mm
H4. Dumping height	585 mm
L1. Length, total	2997 mm
L2. Length, transport	2997 mm
L3. Length, hopper	1524 mm



#### Standard equipment

Poly pad tracks, Backup Alarm, Rotating Beacon Wash down spray system, Dual operator station, Automatic auger feed control Screed Extension & main heat, Auto Flame-Out, Continuous-Ignition Screed Heating Extending Walkboard, Smooth Tandem Pump Steering with a Positive Neutral



#### Optional equipment

Slope Meter mechanical, Cut Off Plates, Umbrella



#### Suitable screeds

Model	Basic width	Working width, hydraulic extendable	Working width, max.	Compacting elements	Heating system
Dynapac VF0813C	2.44 m	4.00 m	4.00 m	Vibration	Propane (LPG)

Find us locally at [www.dynapac.com](http://www.dynapac.com)

We reserve the right to change specifications without notice. Photos and illustrations do not always show standard versions of machines. The above information is a general description only, all informations are supplied without liability.